

KR26 KammRoller Instructions

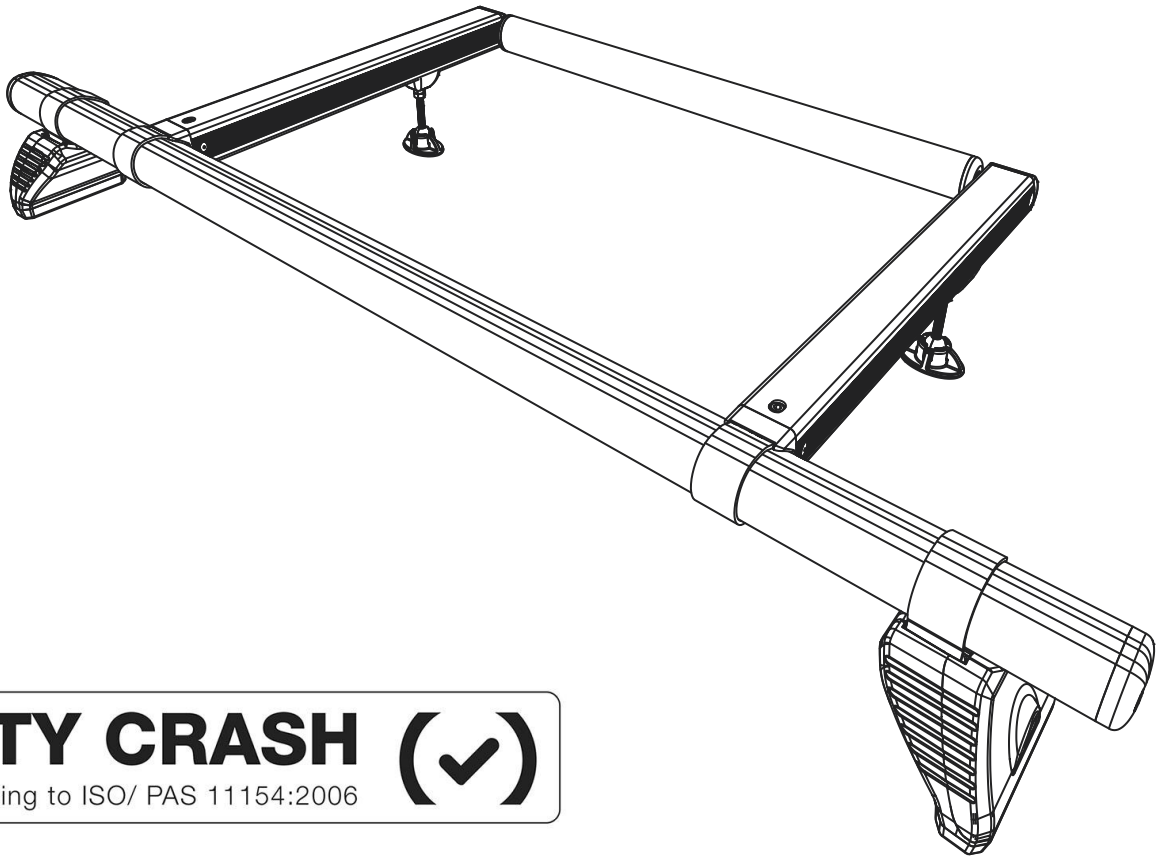

CITY CRASH (✓)

According to ISO/ PAS 11154:2006

Max
50kg/110lbs

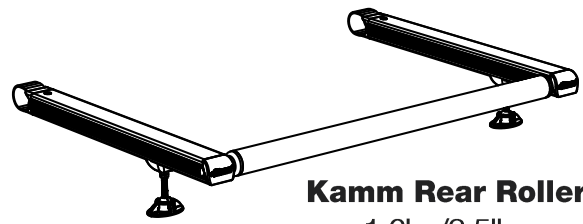
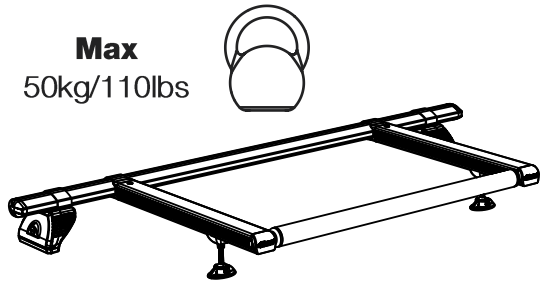

Kamm Rear Roller
1.6kg/3.5lbs

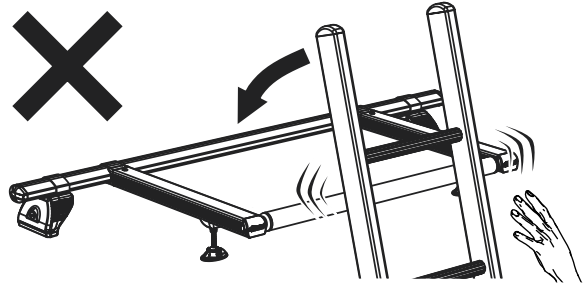
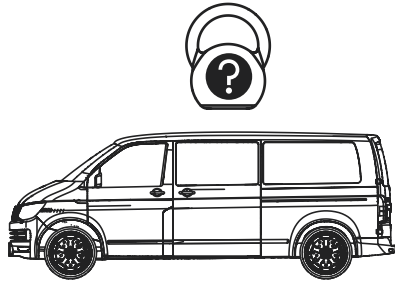

Kamm Rear Roller

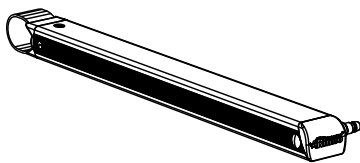

SA408 x 1

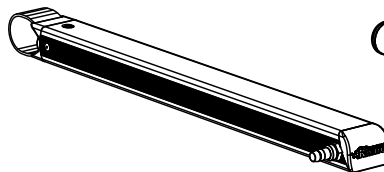

SA409 x 1

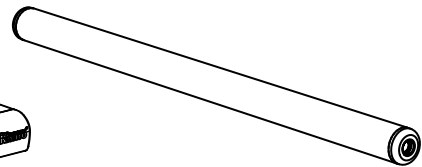

SA401 x 1

Fitting Kit

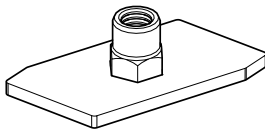

SA527 x 2

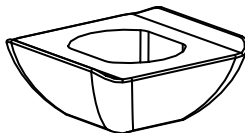

PS202 x 2

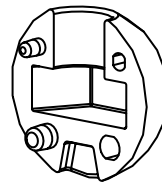

PS203 x 4

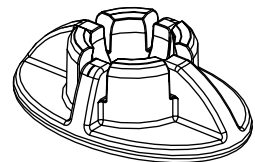

PS204 x 2

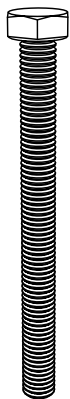

FS316
(M8 x 110) x 2

FS109
(M8 x 90) x 2

FS107
(M8 x 75) x 2

FS105
(M8 x 55) x 2

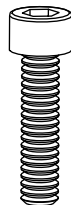

FS103
(M6 x 25) x 2

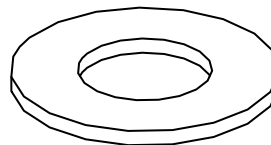

FW021 (M8) x 2

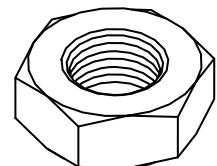

FN039 (M8) x 4

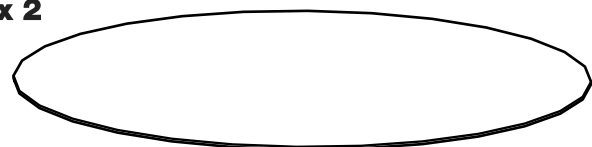

LA074 x 2

1.

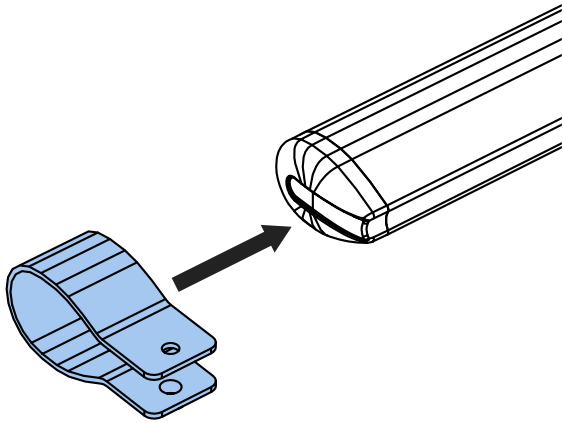

2.

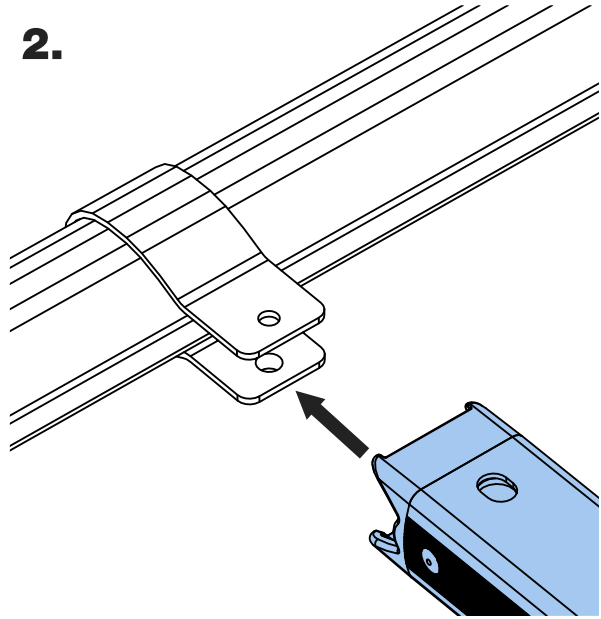

3.

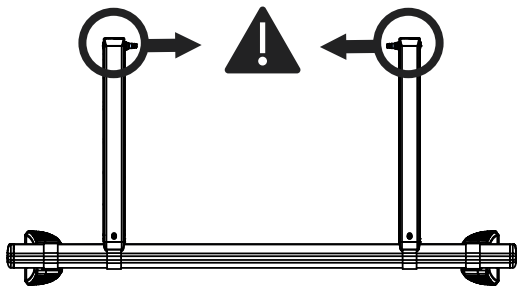

4.

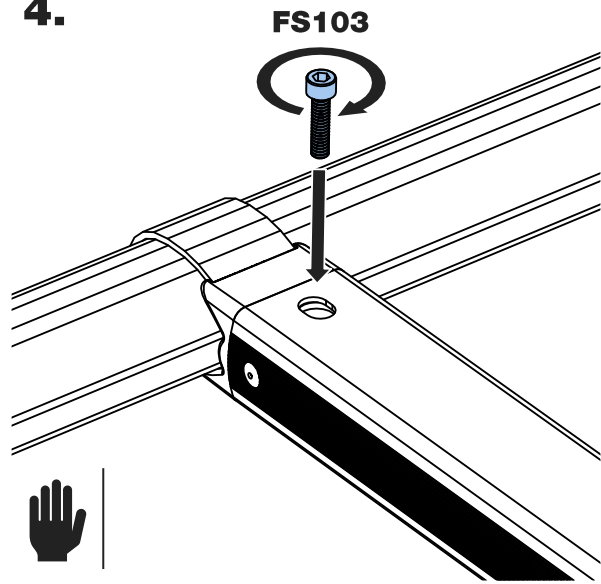

5.

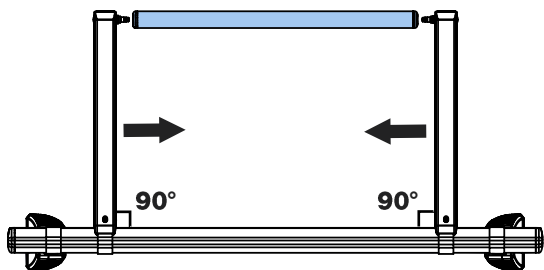

6.

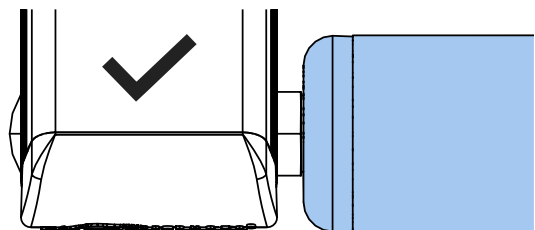
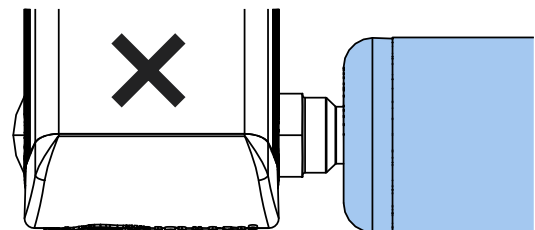

- 7.** 37-52mm = FS105
 57-72mm = FS107
 73-88mm = FS109
 93-108mm = FS316

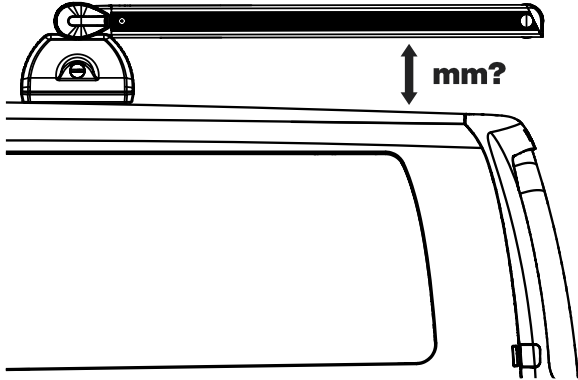

- 8.** FS105/FS107/FS109/FS316

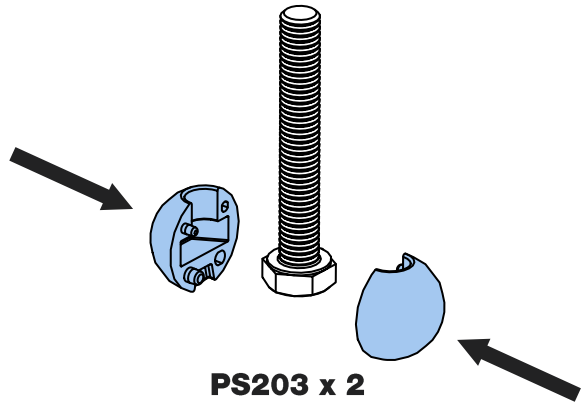

- 9.**

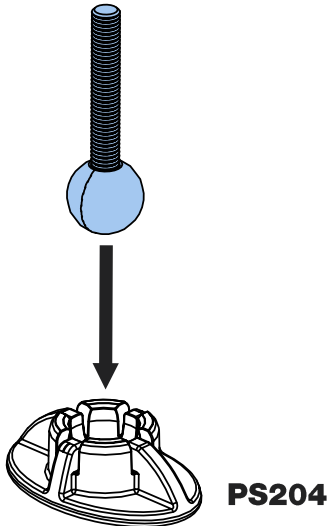

- 10.**

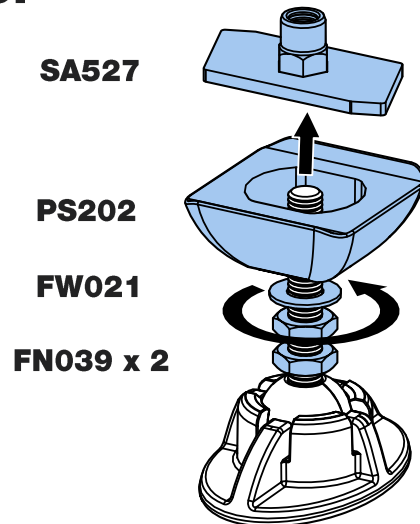

- 11.**

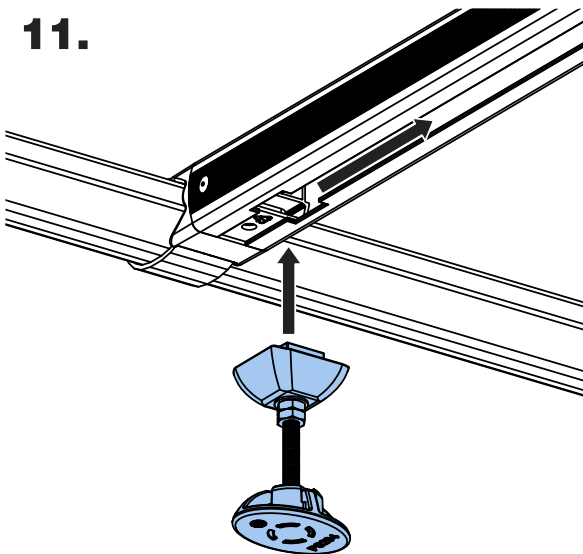

- 12.**

