



ISSUE:	DRAWN BY:	CHECKED BY:	CRF NO:	DATE:	DESCRIPTION:
a	CH	KB	2018	15/11/18	New Issue
b	MK	KB	2640	10/02/22	Updated Artwork to AccessStep.

LA194\_a    AccessStep PS397 Adapter Fitting Sheet    ( 1 Of 2 )



**AccessStep™ connect+®**



**GB: Important!** The assembly instructions **MUST** be followed to ensure correct operation. Failure to do so can result in invalidated warranty and could affect operation.

**FR: Important!** Vous **DEVEZ IMPÉRATIVEMENT** suivre ces instructions d'assemblage pour assurer un fonctionnement correct du produit. Le non-respect de ces instructions peut entraîner une annulation de la garantie et entraver le bon fonctionnement.

**ES: ¡Importante!** Estas instrucciones de montaje **DEBEN** ser seguidas para asegurar el correcto funcionamiento. De no hacerlo, puede resultar inválida la garantía y puede afectar el funcionamiento.

**DE: Wichtiger Hinweis!** Um die fehlerfreie Funktion sicherzustellen, **MUSS** diese Montageanleitung befolgt werden. Andernfalls kann die Garantie erlöschen und die Funktion beeinträchtigt werden.

**NL: Belangrijk!** **VOLG** deze inbouw instructies nauwgezet, zodat het systeem correct functioneert. Onjuiste installatie kan resulteren in een beperking van de werking en tevens de garantie.

**IT: Importante! È NECESSARIO** seguire le presenti istruzioni per il montaggio per garantire un corretto funzionamento. In caso contrario, la garanzia potrebbe essere invalidata e il funzionamento potrebbe risentire.

**PL: UWAGA!** Aby system działał poprawnie, należy postępować dokładnie według instrukcji montażu. Nieprzestrzeganie tego procesu, może wpłynąć na działanie czujników lub też doprowadzić do utraty gwarancji.

**SE: Viktigt!** Monteringsinstruktionerna måste följas noggrant för att säkerställa funktionen. Om så ej görs upphör dels garantin att gälla samt även att själva funktionen kan påverkas.

Manufactured by Rhino Products Ltd in the United Kingdom

Note: Print pages 2 & 3 back to back in colour on A4

IF IN DOUBT PLEASE ASK

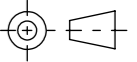

DRAWING NO: <b>LA194 (1 of 3)</b>		DESCRIPTION: <b>AccessStep PS397 Adapter Fitting Sheet</b>		DESIGNED BY: C. Horsefield 15/11/18	
MATERIAL SIZE: n/a		MATERIAL SPEC: Paper		FINISH: Self	
© NOTE: This drawing is the property of Rhino Products Ltd and must not be used or copied without written consent. The Rhino Products name and logo must remain clearly visible in any reproduction.				WEIGHT: 0.31Kg	

 THIRD ANGLE PROJECTION
UNLESS OTHERWISE SPECIFIED: <b>DIMENSIONS ARE IN MM</b> 0.00 ±0.2 0.0 ±0.5 ANG ±0.5° DERIVED DIMENSIONS SHOWN IN BRACKETS
DEBURR AND BREAK ALL SHARP EDGES
SHEET SIZE A3    SHEET SCALE: 4:5



**Rhino** PRODUCTS **AccessStep**™ **connect**+®



GB: **Important!** The assembly instructions **MUST** be followed to ensure correct operation. Failure to do so can result in invalidated warranty and could affect operation.

FR: **Important!** Vous **DEVEZ IMPÉRATIVEMENT** suivre ces instructions d'assemblage pour assurer un fonctionnement correct du produit. Le non-respect de ces instructions peut entraîner une annulation de la garantie et entraver le bon fonctionnement.

ES: **¡Importante!** Estas instrucciones de montaje **DEBEN** ser seguidas para asegurar el correcto funcionamiento. De no hacerlo, puede resultar inválida la garantía y puede afectar el funcionamiento.

DE: **Wichtiger Hinweis!** Um die fehlerfreie Funktion sicherzustellen, **MUSS** diese Montageanleitung befolgt werden. Andernfalls kann die Garantie erlöschen und die Funktion beeinträchtigt werden.

NL: **Belangrijk!** **VOLG** deze inbouw instructies nauwgezet, zodat het systeem correct functioneert. Onjuiste installatie kan resulteren in een beperking van de werking en tevens de garantie.

IT: **Importante!** **È NECESSARIO** seguire le presenti istruzioni per il montaggio per garantire un corretto funzionamento. In caso contrario, la garanzia potrebbe essere invalidata e il funzionamento potrebbe risentirne.

PL: **UWAGA!** Aby system działał poprawnie, należy postępować dokładnie według instrukcji montażu. Nieprzestrzeganie tego procesu, może wpłynąć na działanie czujników lub też doprowadzić do utraty gwarancji.

SE: **Viktigt!** Monteringsinstruktionerna måste följas noggrant för att säkerställa funktionen. Om så ej görs upphör dels garantin att gälla samt även att själva funktionen kan påverkas.



GB: **ALWAYS** support the sensor adapter from the outside while fitting the vehicle sensors.

FR: Toujours veiller à un bon support des adaptateurs du capteur lors du montage des capteurs du véhicule.

ES: Sujete siempre el adaptador de sensor mientras instale sensores de vehículos.

DE: Es ist darauf zu achten, dass der Sensoradapter beim Anbringen der Fahrzeugsensoren immer gestützt wird.

NL: Ondersteun de sensorhouders tijdens de installatie van de voertuigsensors.

IT: Sostenere sempre l'adattatore del sensore durante l'installazione dei sensori del veicolo.

PL: Zawsze podtrzymuj adaptery podczas montażu czujników.

SW: Ge sensoradaptern stöd när fordonets sensorer monteras.

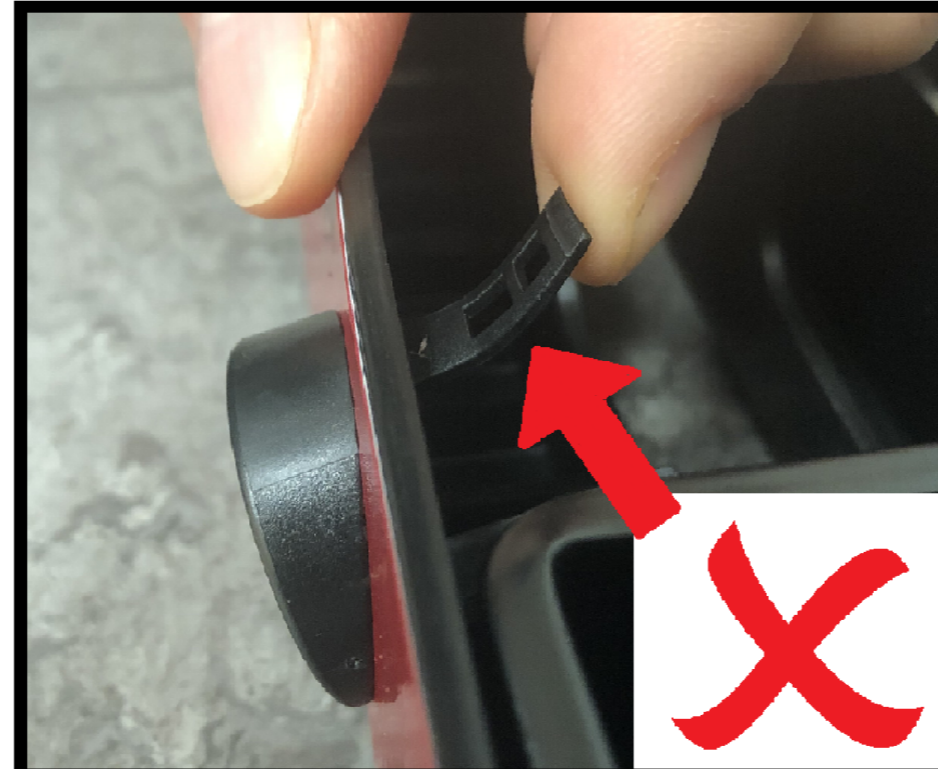

GB: **DO NOT** over bend the adapter arms when inserting the vehicle sensors.

FR: Ne pas courber les bras de l'adaptateur lors de l'insertion des capteurs.

ES: No doble demasiado los brazos de los adaptadores cuando inserte sensores.

DE: Die Adapterarme beim Einsetzen der Sensoren nicht überbiegen.

NL: Buig de sensorhouder-armen niet te ver naar buiten

IT: Non piegare eccessivamente i bracci dell'adattatore durante l'inserimento dei sensori.

PL: Podczas wkładania czujników parkowania do adapterów, należy pamiętać, aby nadmiernie nie zginać ramion adaptera.

SW: öj ej adapterns armar för mycket när sensorer monteras.

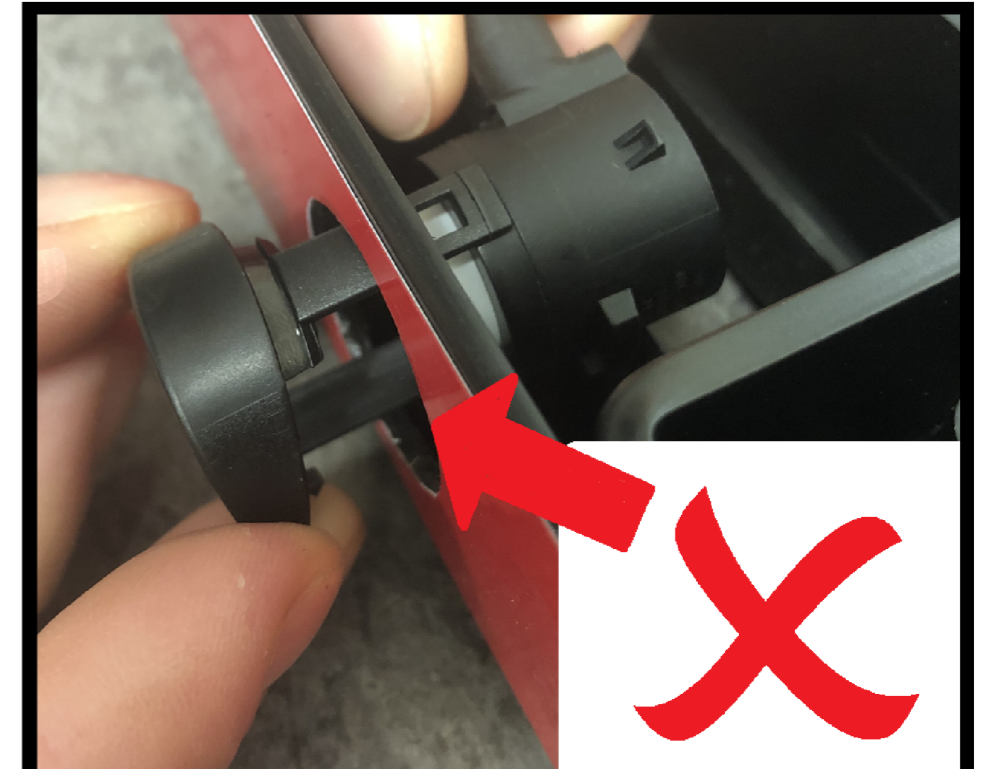

GB: **DO NOT** de-mount the adapters from the step when fitting the sensors

FR: Veillez à ne pas démonter les adaptateurs du marchepied lors du montage des capteurs.

ES: Tenga cuidado en no desmontar adaptadores del escalón cuando instale sensores.

DE: Darauf achten, dass beim Anbringen der Sensoren keine Adapter von der Trittstufe abmontiert werden.

NL: Zorg ervoor dat de sensorhouders niet uit de opstap worden gedrukt, tijdens de installatie van de sensors.

IT: Fare attenzione a non smontare gli adattatori dal gradino durante l'installazione dei sensori.

PL: Nie należy wyjmować adapterów ze stopnia, podczas montażu czujników.

SW: Iakttag försiktighet när sensorerna monteras så att inte adapterna skjuts ur steget.

ISSUE:	DRAWN BY:	CHECKED BY:	CRF NO:	DATE:	DESCRIPTION:
g	MK	KB	2974	05/06/23	Added 4x PS573
h	SJ	KB	3243	16/05/24	Added PS043 x4 and added instructions for the Renault Traffic 2021-
i	AH	SJ	3311	24/7/24	Update wiring loom labels to A/B/C/D
j	FT	KB	3383	03/12/24	Added instructions for Renault Master 2024- XDD

PA26 x 1  
8" x 10" Polythene Bag, 250G

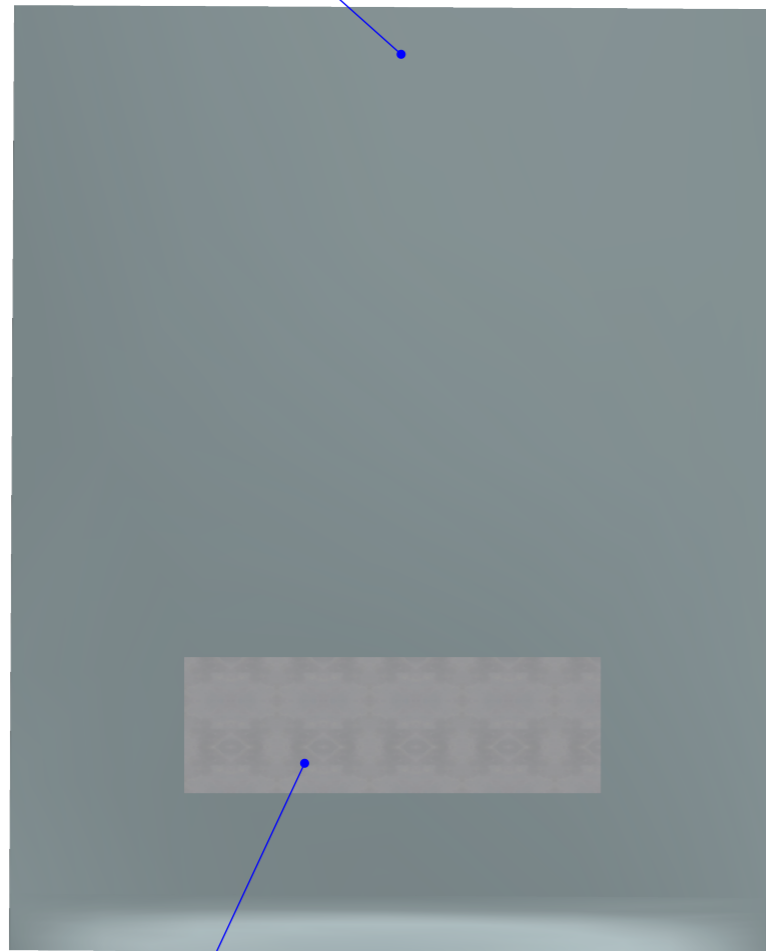

LA021 x 1  
Printed Label, Kit Box

PS573 x 4  
22mm x 11.5mm Round Insert



PS558 x 4  
20mm x 11.5mm Round Insert



PS366 x 4  
Rear Spacer for Reverse Sensor Adapters



PS397 x 2  
Safestep & Towstep OEM Reverse Sensor Adapter - 18 Degree Angle

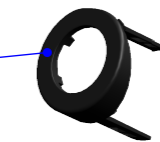

2010172 - PS043 x 8  
Cable Tie (Black) 2.5 x 100mm



PS064 x 4  
Cable Tie, 292 x 3.6mm (Black)

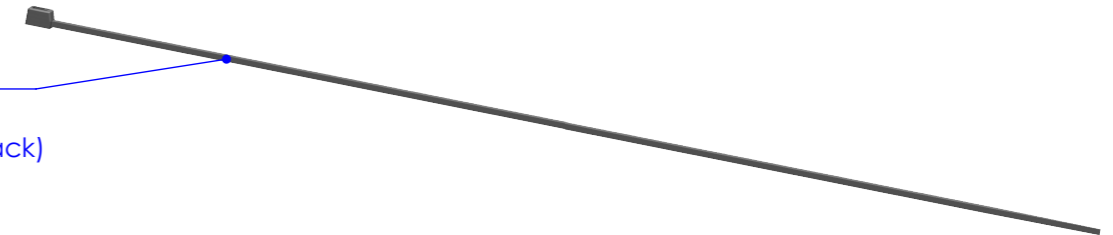

INFK1001 x 1  
Customer Instruction Sheet(s)

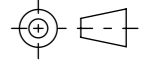

DRAWING NO: <b>FK1001 (1 of 7)</b>		DESCRIPTION: <b>Safestep OEM Reverse Sensor Blanking Kit</b>		DESIGNED BY: C. Horsefield 15/12/17	
MATERIAL SIZE: n/a		MATERIAL SPEC: n/a		WEIGHT: 0.01Kg	
FINISH: n/a		© NOTE: This drawing is the property of Rhino Products Ltd and must not be used or copied without written consent. The Rhino Products name and logo must remain clearly visible in any reproduction.			

 THIRD ANGLE PROJECTION	
UNLESS OTHERWISE SPECIFIED: <b>DIMENSIONS ARE IN MM</b>	
0.00	±0.2
0.0	±0.5
ANG	±0.5°
DERIVED DIMENSIONS SHOWN IN BRACKETS	
DEBURR AND BREAK ALL SHARP EDGES	
SHEET SIZE A3	SHEET SCALE: 1:2

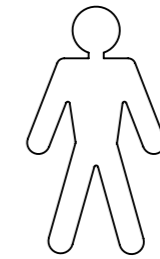
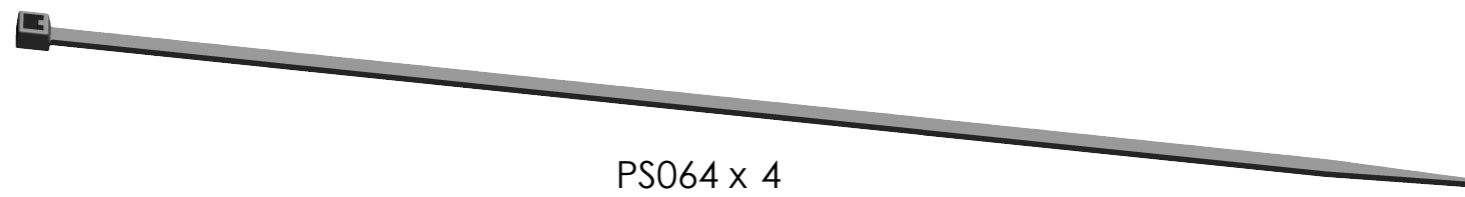
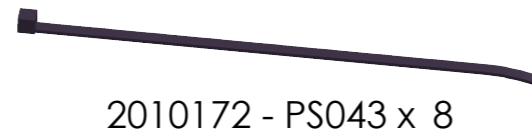

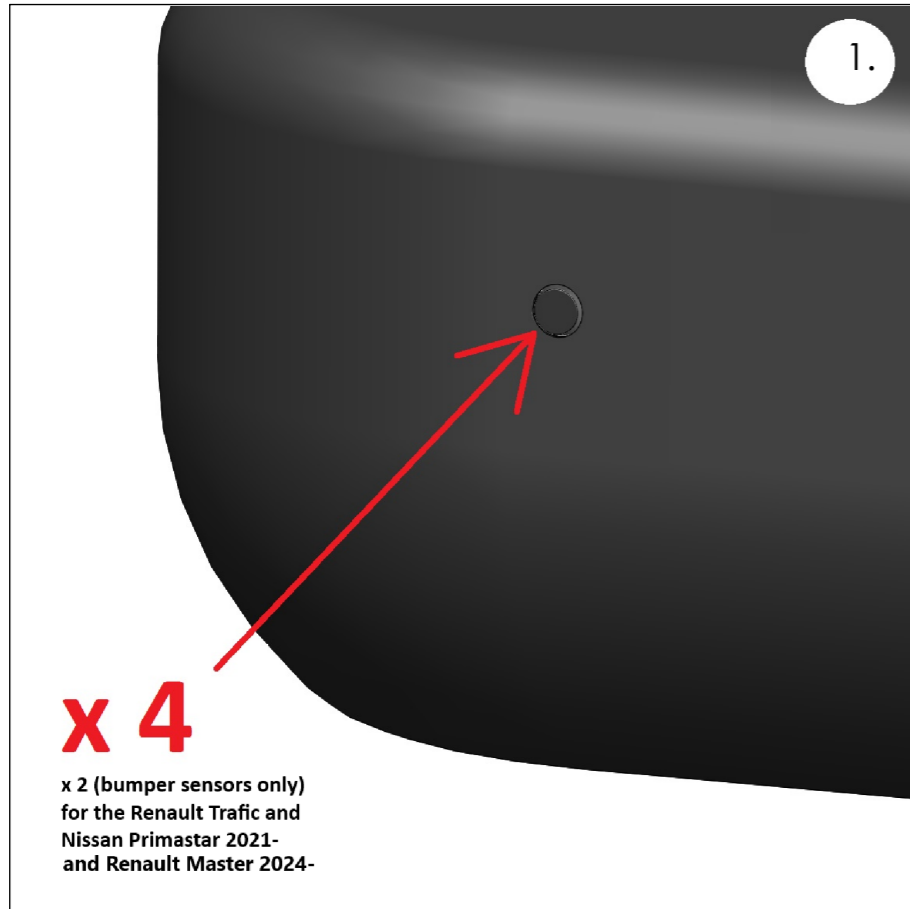





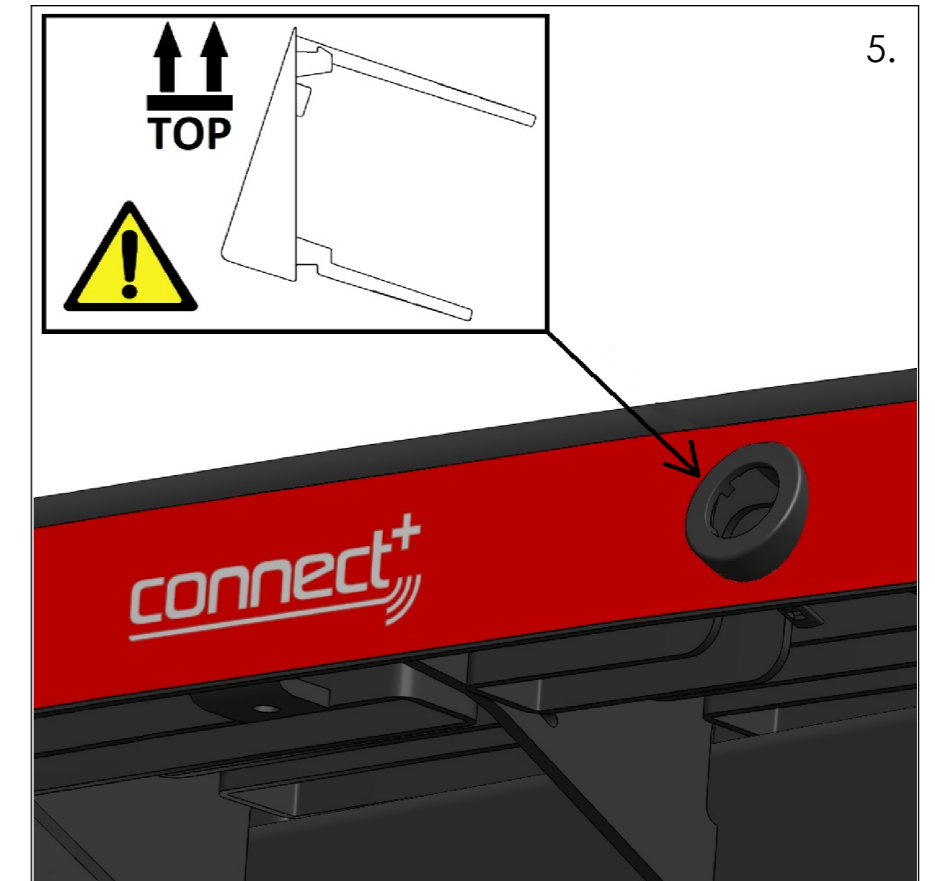
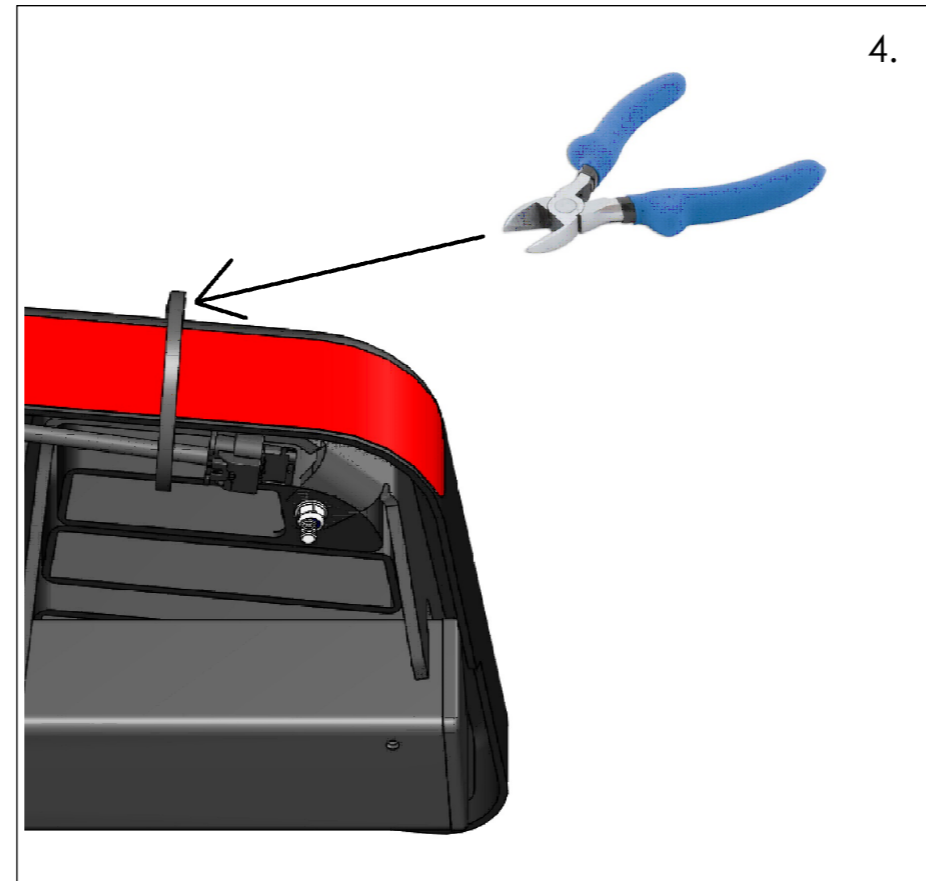
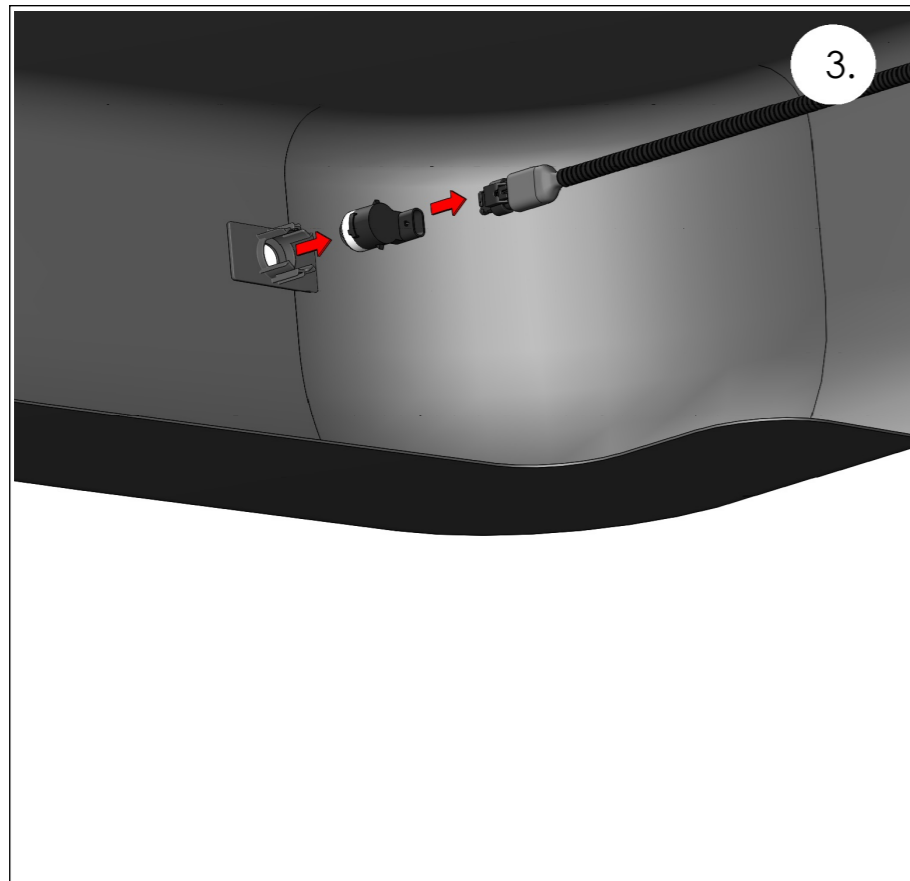













2.

2017- VW Crafter 2017- MAN TGE	2014- VW Transporter T6 1999-2014 VW T5	2014- Ford Transit 2013- Ford Transit Custom	2006- Mercedes Sprinter 2006-2017 VW Crafter	Iveco Daily (2014-)
✓	✗	✓	✓	✗
2006- Citroen Relay/Jumper 2006- Peugeot Boxer 2008- Fiat Ducato 2022- Vauxhall/Opel Movano	2016- Toyota Proace 2018- Peugeot Expert	2019- Vauxhall/Opel Vivaro 2018- Citroen Dispatch 2022- Fiat Scudo	2010-2024 Renault Master 2010-2021 Vauxhall/Opel Movano 2010 - Nissan NV400	2021- Renault Trafic 2021- Nissan Primastar 2024- Renault Master
✓	✗	✗	✓	✗





<p><b>2017- VW Crafter</b> <b>2017- MAN TGE</b></p> 	<p><b>2014- VW Transporter T6</b> <b>1999-2014 VW T5</b></p> 	<p><b>2006- Mercedes Sprinter</b> <b>2006-2017 VW Crafter</b></p> 
<p>PS366</p>  	<p>PS366</p>  	<p>PS366</p>  
<p><b>2016- Peugeot Expert</b> <b>2016- Toyota Proace</b> <b>2016- Citroen Dispatch</b> <b>2019- Vauxhall Vivaro</b> <b>2022- Fiat Scudo</b></p> 	<p><b>2010-2024 Renault Master</b> <b>2010- Nissan NV400</b> <b>2010-2021 Vauxhall/Opel Movano</b></p> 	<p><b>2006- Fiat Ducato</b> <b>2006- Peugeot Boxer</b> <b>2006-Citroen Relay/Jumper</b> <b>2022- Vauxhall/Opel Movano</b></p> 
<p>PS366</p>  	<p>PS366</p>  	<p>PS366</p>  

**2020- Ford Transit  
(JU5T-15K859-BC)  
2018- Ford Transit Custom  
(HU5T-15K859-AAW)**





---

**PS366**  

**2014-20 Ford Transit  
(GK2T-15K859-EA)  
2012-18 Ford Transit Custom  
(CJ5T-15K859-AWW)**



---

**PS366**  

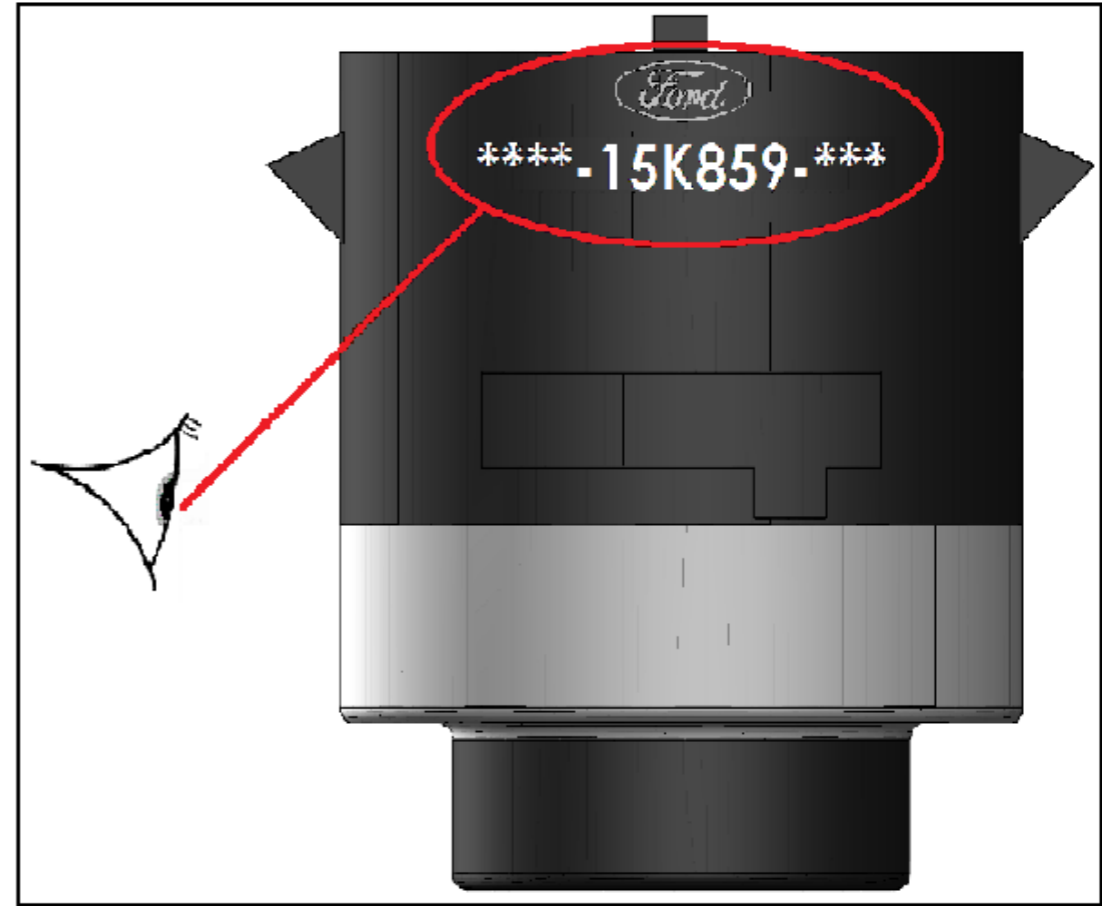

**2014 - Iveco Daily**



---

**PS366**  

**2021- Renault Traffic  
2021- Nissan Primastar  
2024- Renault Master  
2024- Nissan Interstar**



---

<b>PS366</b>  	<b>PS043</b>  
---	--

