

# KR30 KammRoller

## Instructions

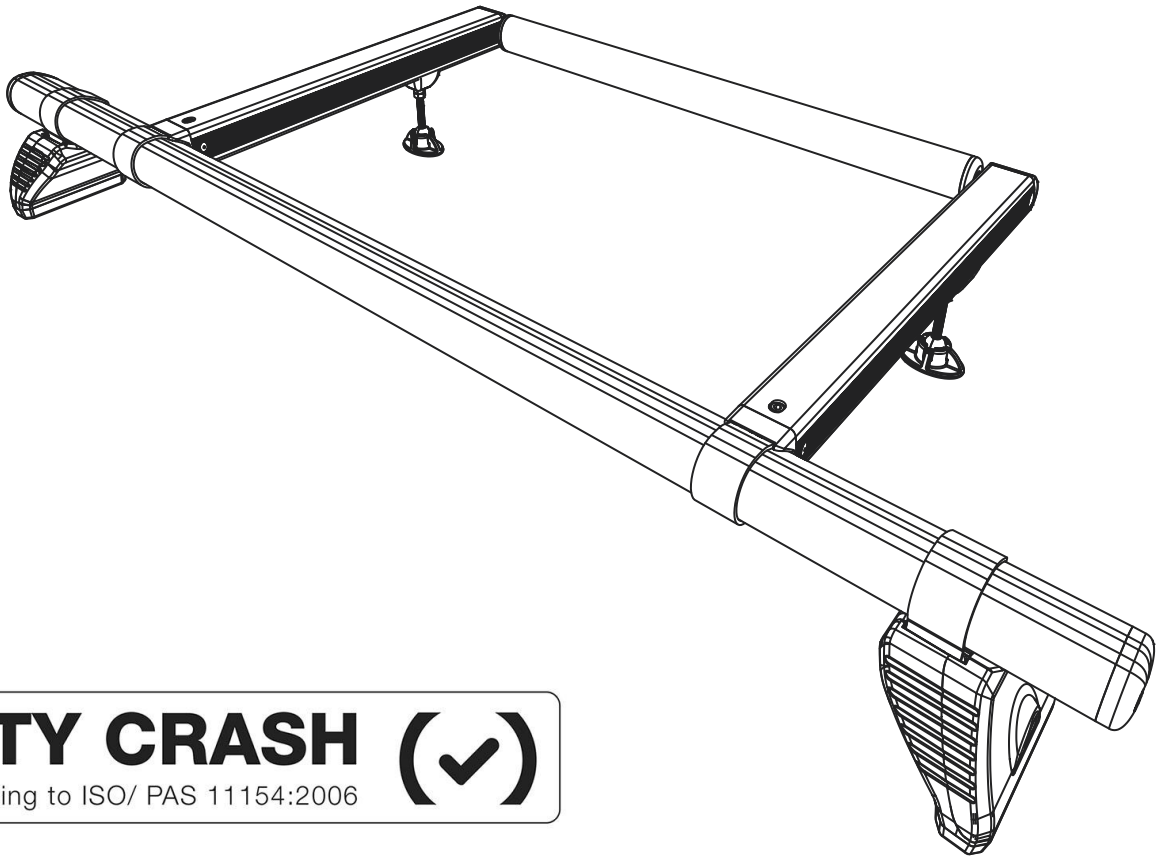

**CITY CRASH (✓)**

According to ISO/ PAS 11154:2006

**Max**  
50kg/110lbs

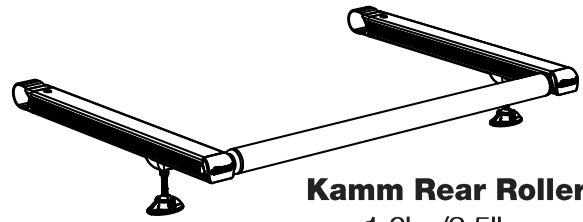
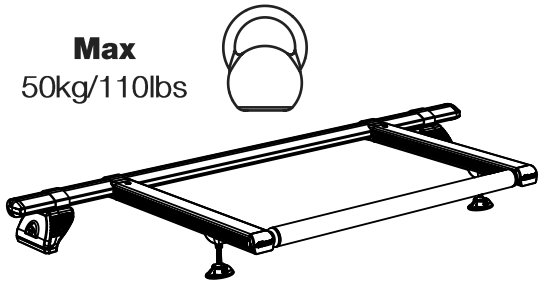

**Kamm Rear Roller**  
1.6kg/3.5lbs

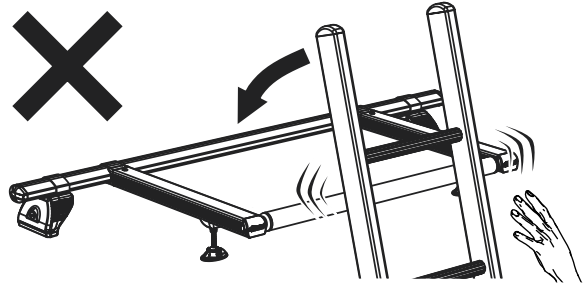
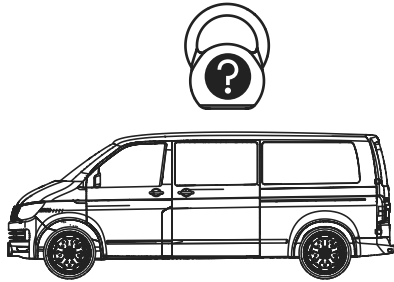

## Kamm Rear Roller

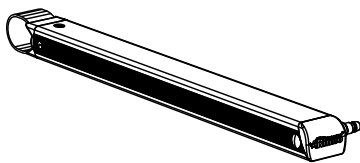

**SA410 x 1**

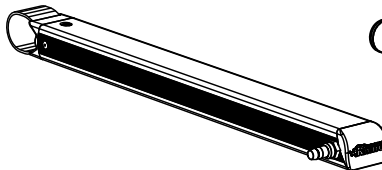

**SA411 x 1**

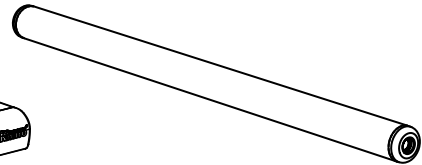

**SA402 x 1**

## Fitting Kit

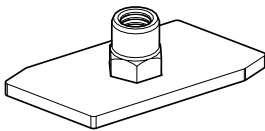

**SA527 x 2**

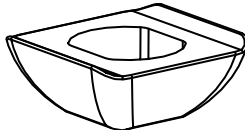

**PS202 x 2**

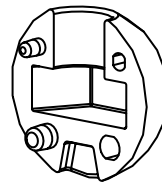

**PS203 x 4**

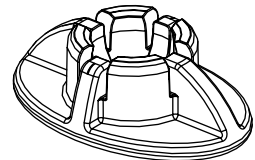

**PS204 x 2**



**FS316**  
**(M8 x 110) x 2**

**FS109**  
**(M8 x 90) x 2**

**FS107**  
**(M8 x 75) x 2**

**FS105**  
**(M8 x 55) x 2**

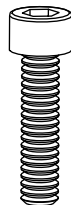

**FS103**  
**(M6 x 25) x 2**

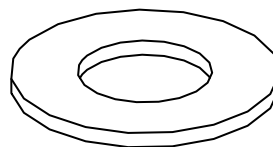

**FW021 (M8) x 2**

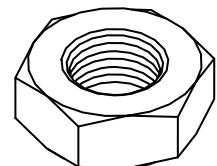

**FN039 (M8) x 4**

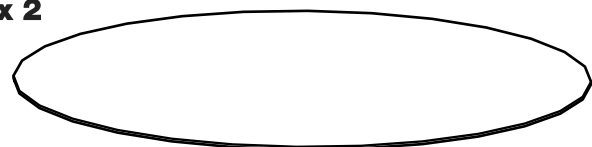

**LA074 x 2**

1.

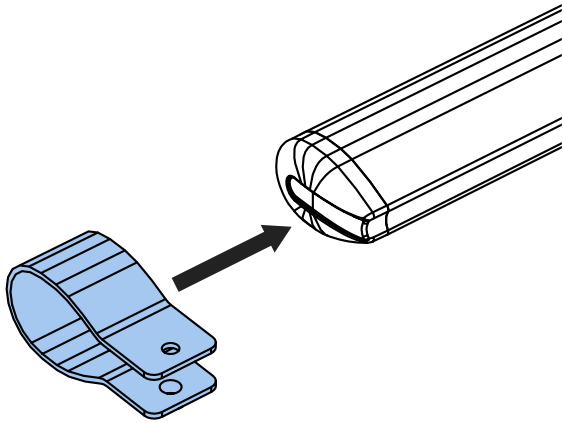

2.

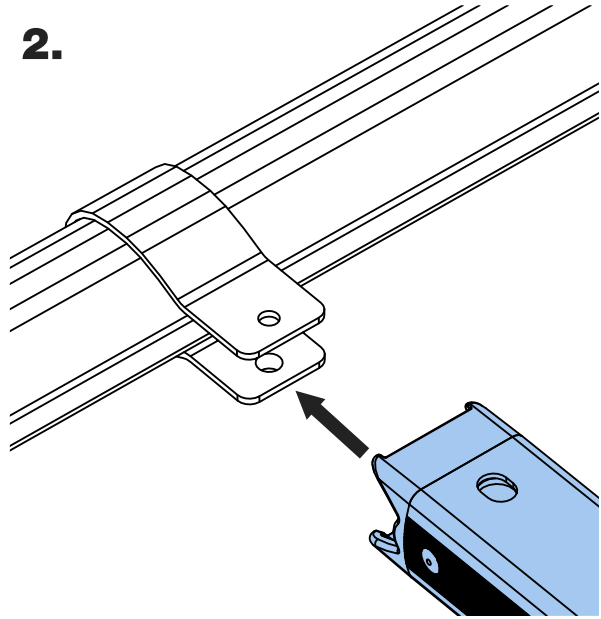

3.

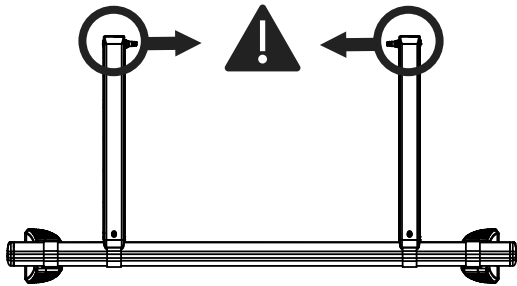

4.

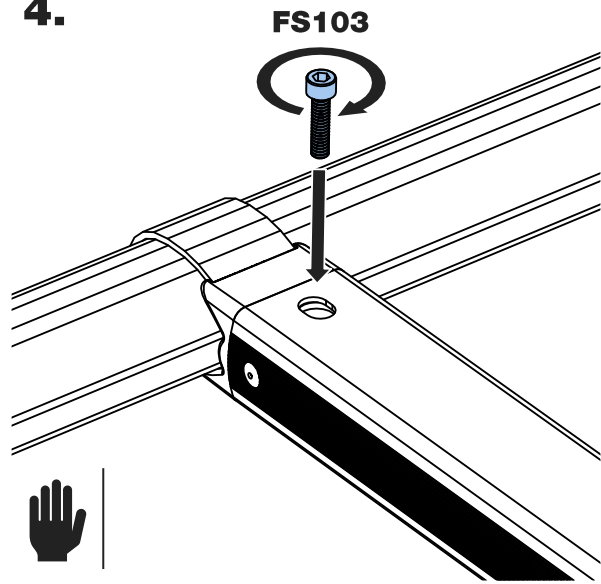

5.

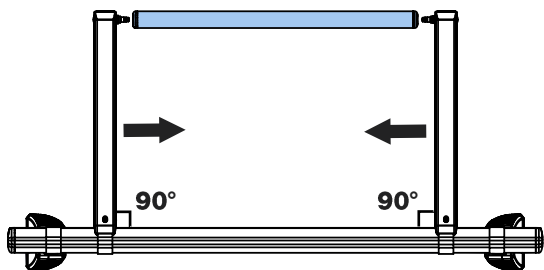

6.

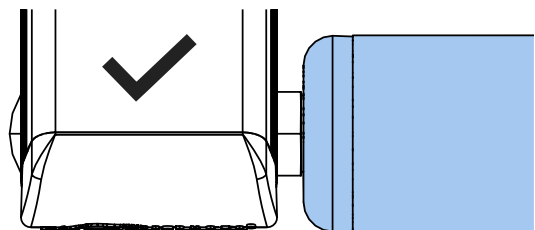
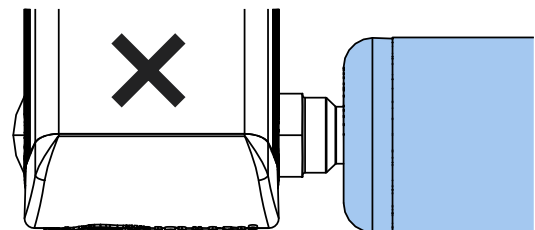

- 7.**  
 37-52mm = FS105  
 57-72mm = FS107  
 73-88mm = FS109  
 93-108mm = FS316

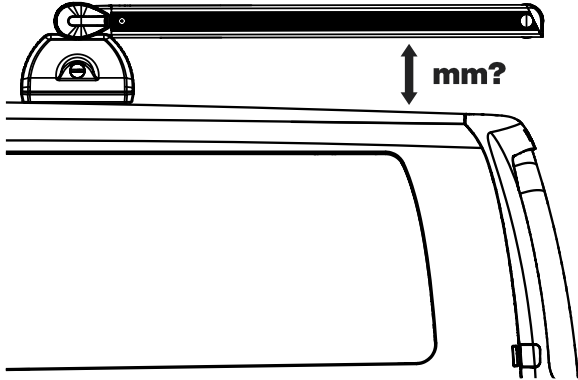

- 8.**  
 FS105/FS107/FS109/FS316

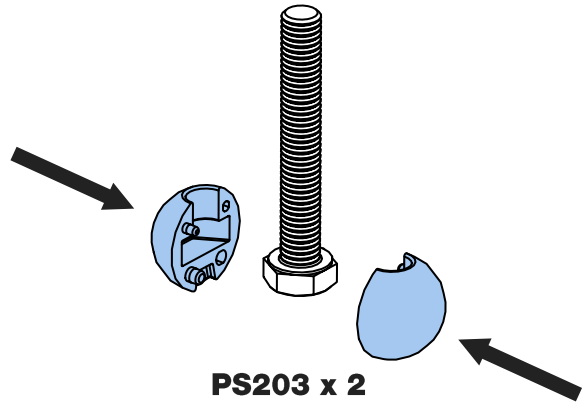

- 9.**

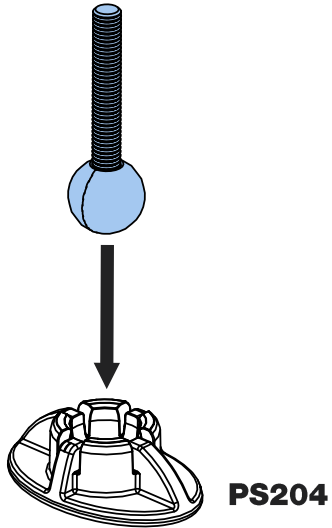

- 10.**

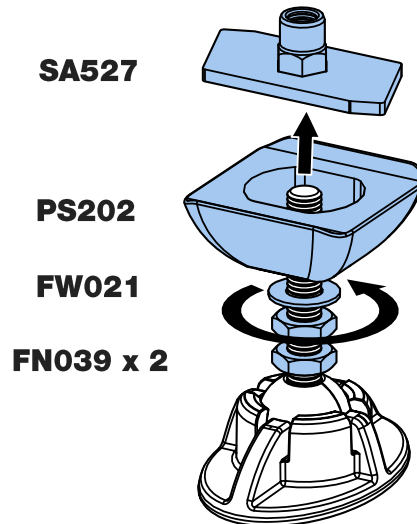

- 11.**

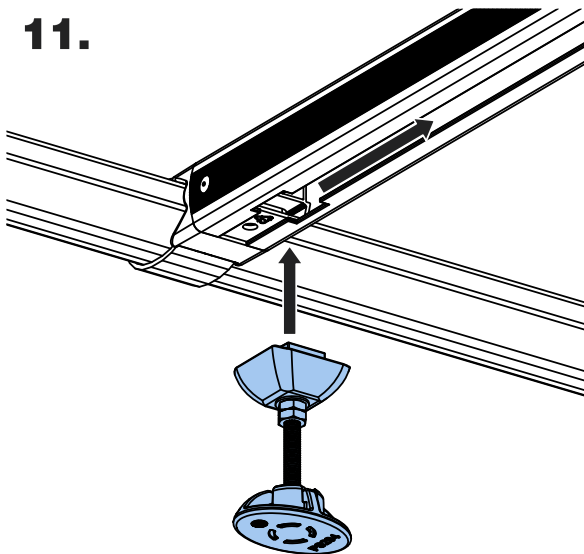

- 12.**

